

Stainless Steel Bathroom Floor Drains SLKN 17

Characteristics

BATHROOM DRAIN

- length L = 850 mm
- collar serves for a tight and reliable connection to hydro-isolation
- collar with the frame sealed up against the moisture
- mounting legs with M10 screws for better seating of the drain to the floor (horizontal position)
- 2 pcs. of waterproofing tapes for fixation to base, including screws and wall plugs
- side bends for better stability
- bond screw for connection with bonding conductor
- different lengths could be made to order (till 1200 mm - depression to the waste, over 1200 mm - decline to the waste)
- load class K3 (till 300 kg)
- material AISI-304

WASTE OUTLET

- plastic siphon DN 50 mm
- according to the norm DIN EN 274; rate of flow 42 l/min
- possibility of adjustment of the direction and the slope of the drain to 20°
- different siphon positions could be made to order

GRID

- design of grids A - F
- index X - brushed finish
- material stainless steel AISI - 304
- other designs could be made to order

Grid Designs

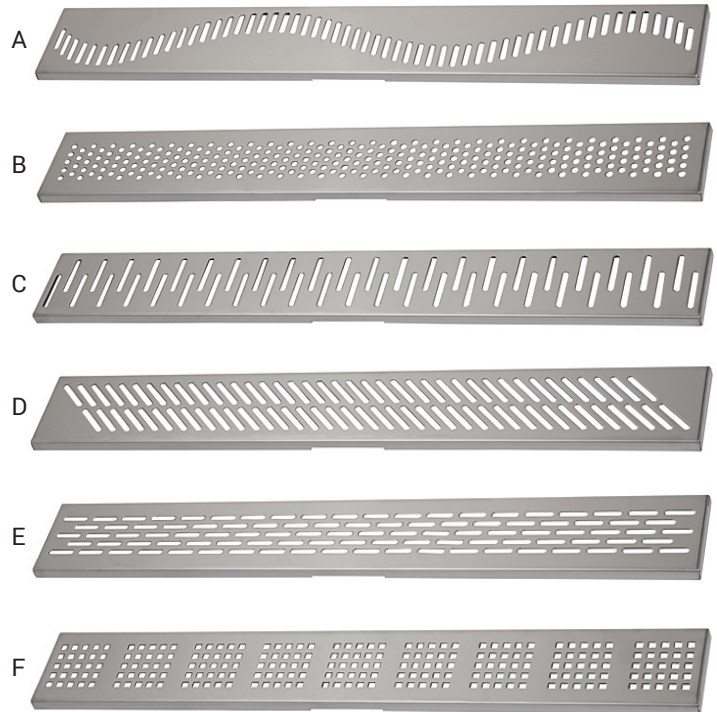

Drains for open space



Dimensions

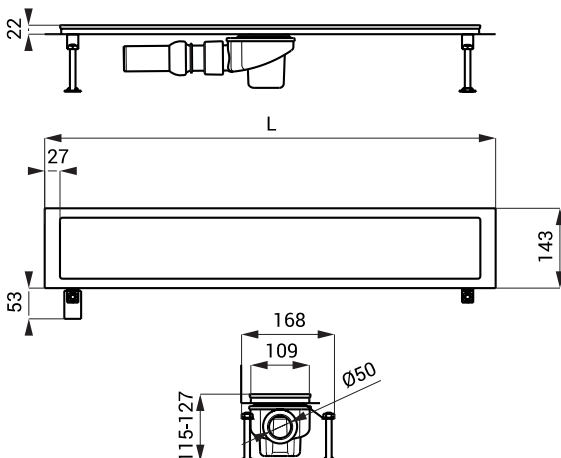

Supply Specification

SLKN 17A - Supply No. 69171	drain, grid A, polished finish, siphon, mounting legs with M10 screw (4 pcs.), tool for grid remove, waterproofing tape, mounting set
SLKN 17AX - Supply No. 68171	drain, grid A, brushed finish, siphon, mounting legs with M10 screw (4 pcs.), tool for grid remove, waterproofing tape, mounting set
SLKN 17B - Supply No. 69172	drain, grid B, polished finish, siphon, mounting legs with M10 screw (4 pcs.), tool for grid remove, waterproofing tape, mounting set
SLKN 17BX - Supply No. 68172	drain, grid B, brushed finish, siphon, mounting legs with M10 screw (4 pcs.), tool for grid remove, waterproofing tape, mounting set
SLKN 17C - Supply No. 69173	drain, grid C, polished finish, siphon, mounting legs with M10 screw (4 pcs.), tool for grid remove, waterproofing tape, mounting set
SLKN 17CX - Supply No. 68173	drain, grid C, brushed finish, siphon, mounting legs with M10 screw (4 pcs.), tool for grid remove, waterproofing tape, mounting set
SLKN 17D - Supply No. 69174	drain, grid D, polished finish, siphon, mounting legs with M10 screw (4 pcs.), tool for grid remove, waterproofing tape, mounting set
SLKN 17DX - Supply No. 68174	drain, grid D, brushed finish, siphon, mounting legs with M10 screw (4 pcs.), tool for grid remove, waterproofing tape, mounting set
SLKN 17E - Supply No. 69175	drain, grid E, polished finish, siphon, mounting legs with M10 screw (4 pcs.), tool for grid remove, waterproofing tape, mounting set
SLKN 17EX - Supply No. 68175	drain, grid E, brushed finish, siphon, mounting legs with M10 screw (4 pcs.), tool for grid remove, waterproofing tape, mounting set
SLKN 17F - Supply No. 69176	drain, grid F, polished finish, siphon, mounting legs with M10 screw (4 pcs.), tool for grid remove, waterproofing tape, mounting set
SLKN 17FX - Supply No. 68176	drain, grid F, brushed finish, siphon, mounting legs with M10 screw (4 pcs.), tool for grid remove, waterproofing tape, mounting set