

Stainless Steel Bathroom Floor Drain SLKN 10



Characteristics

BATHROOM DRAIN

- length L = 950 mm
- collar serves for a tight and reliable connection to hydro-isolation
- collar with the frame sealed up against the moisture
- mounting legs with M10 screws for better seating of the drain to the floor (horizontal position)
- 2 pcs. of waterproofing tapes for fixation to base, including screws and wall plugs
- side bends for better stability
- bond screw for connection with bonding conductor
- different lengths could be made to order (till 1200 mm - depression to the waste, over 1200 mm - decline to the waste)
- load class K3 (till 300 kg)
- material AISI-304

WASTE OUTLET

- plastic siphon DN 50 mm
- according to the norm DIN EN 274; rate of flow 42 l/min
- possibility of adjustment of the direction and the slope of the drain to 20°
- different siphon positions could be made to order

Dimensions

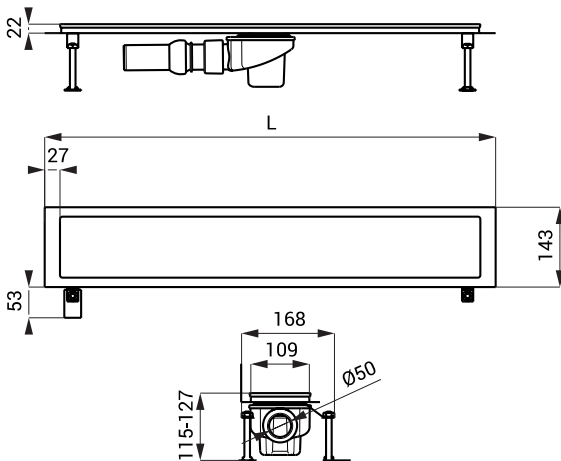

Supply Specification

SLKN 10 - Supply No. 69100

drain, stainless steel tub (for tiles insert, max. height of tiles 12 mm - drain for higher tiles could be made to order), siphon, mounting legs with M10 screw (4 pcs.), tool for grid remove, waterproofing tape, mounting set