



SLZM 10



SLZM 10 **49100** Stainless steel grab bar universal, fixed

SLZM 10X **49101** Stainless steel grab bar universal, fixed

- for disabled and persons with limited mobility

- mounting set
- length 385 mm, Ø 32 mm
- polished finish (SLZM 10)
- brushed finish (SLZM 10X)

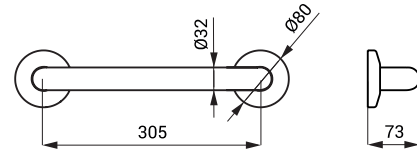

SLZM 11



SLZM 11 **49110** Stainless steel grab bar universal, fixed

SLZM 11X **49111** Stainless steel grab bar universal, fixed

- for disabled and persons with limited mobility

- mounting set
- length 537 mm, Ø 32 mm
- polished finish (SLZM 11)
- brushed finish (SLZM 11X)

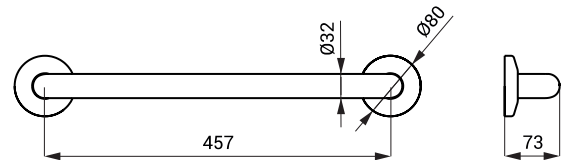

SLZM 12



SLZM 12 **49120** Stainless steel grab bar universal, fixed

SLZM 12X **49121** Stainless steel grab bar universal, fixed

- for disabled and persons with limited mobility

- mounting set
- length 690 mm, Ø 32 mm
- polished finish (SLZM 12)
- brushed finish (SLZM 12X)

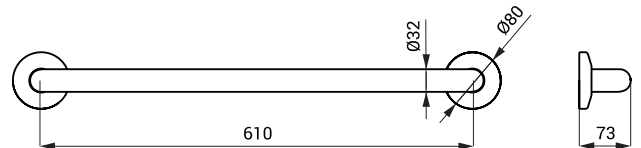

SLZM 10W **49102** Steel grab bar universal, fixed

SLZM 11W **49112** Steel grab bar universal, fixed

SLZM 12W **49122** Steel grab bar universal, fixed

- for disabled and persons with limited mobility

- mounting set
- length 385 mm (SLZM 10W), Ø 32 mm
- length 537 mm (SLZM 11W), Ø 32 mm
- length 690 mm (SLZM 12W), Ø 32 mm
- white colour - Komaxit

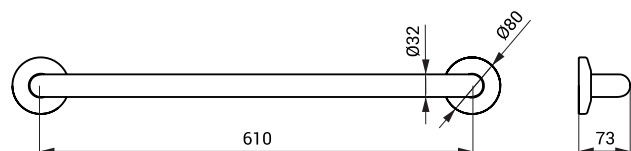
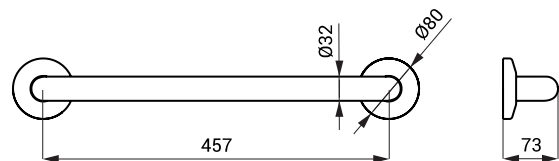
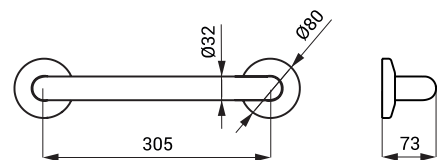



SLZM 13



SLZM 13 **49130** Stainless steel grab bar, fixed

SLZM 13X **49131** Stainless steel grab bar, fixed

- for disabled and persons with limited mobility

- mounting set
- length 600 mm, Ø 32 mm
- polished finish (SLZM 13)
- brushed finish (SLZM 13X)

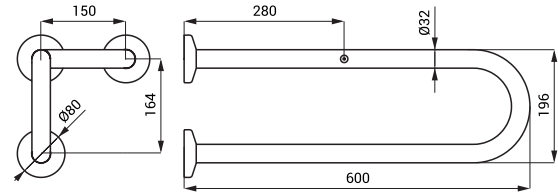

SLZM 14



SLZM 14 **49140** Stainless steel grab bar, fixed

SLZM 14X **49141** Stainless steel grab bar, fixed

- for disabled and persons with limited mobility

- mounting set
- length 800 mm, Ø 32 mm
- polished finish (SLZM 14)
- brushed finish (SLZM 14X)

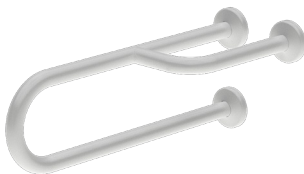
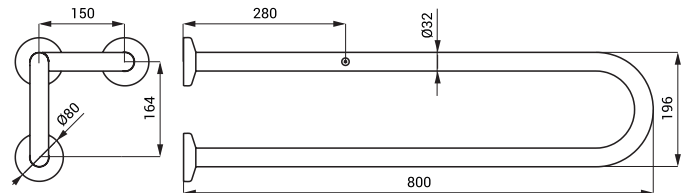

SLZM 13W **49132** Steel grab bar, fixed

SLZM 14W **49142** Steel grab bar, fixed

- for disabled and persons with limited mobility

- mounting set
- length 600 mm, Ø 32 mm
- length 800 mm, Ø 32 mm
- white colour - Komaxit

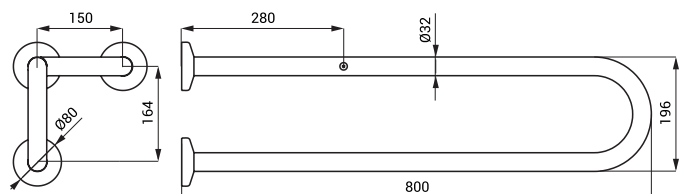
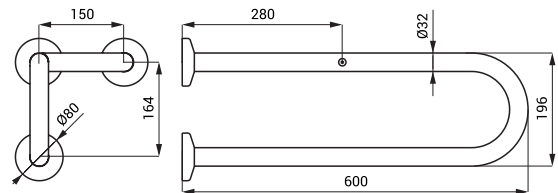



SLZM 20 **49200** Stainless steel grab bar, fixed

- for disabled and persons with limited mobility
- mounting set
- length 900 mm, Ø 32 mm
- polished finish

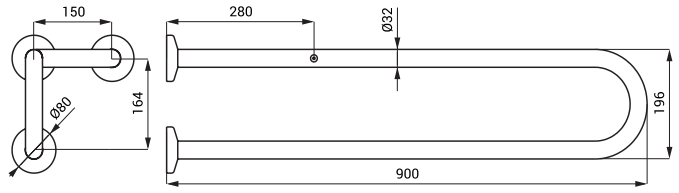

SLZM 20X **49201** Stainless steel grab bar, fixed

- for disabled and persons with limited mobility
- mounting set
- length 900 mm, Ø 32 mm
- brushed finish

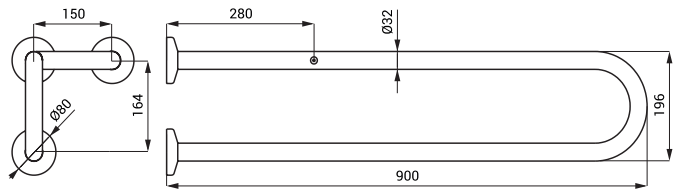
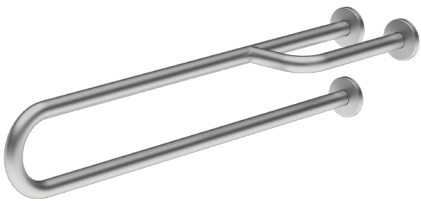

SLZM 20W **49202** Steel grab bar, fixed

- for disabled and persons with limited mobility
- mounting set
- length 900 mm, Ø 32 mm
- white colour - Komaxit

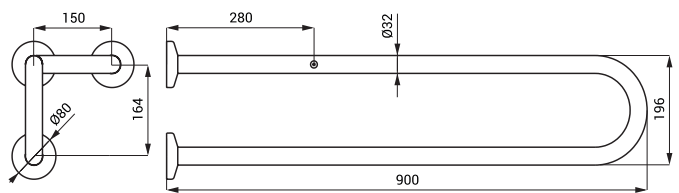
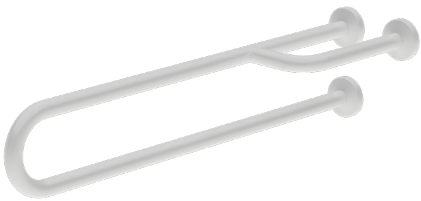

SLZM 15 **49150** Stainless steel grab bar, folding

SLZM 15X **49151** Stainless steel grab bar, folding

- for disabled and persons with limited mobility
- length 600 mm, Ø 32 mm
- polished finish (SLZM 15)
- brushed finish (SLZM 15X)



SLZM 15

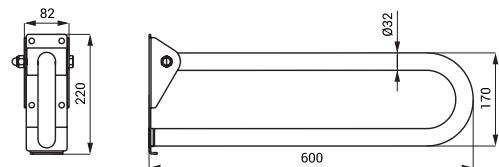



SLZM 16



SLZM 16 **49160** Stainless steel grab bar, folding

SLZM 16X **49161** Stainless steel grab bar, folding

- for disabled and persons with limited mobility
- length 800 mm, Ø 32 mm
- polished finish (SLZM 16)
- brushed finish (SLZM 16X)

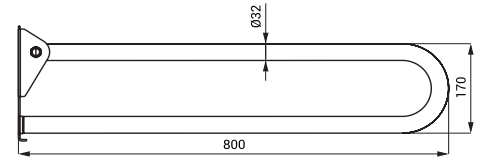
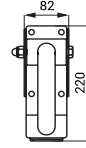

SLZM 15W **49152** Steel grab bar, folding

SLZM 16W **49162** Steel grab bar, folding

- for disabled and persons with limited mobility
- length 600 mm, Ø 32 mm
- length 800 mm, Ø 32 mm
- white colour - Komaxit

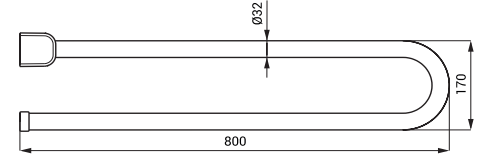
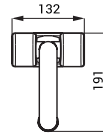
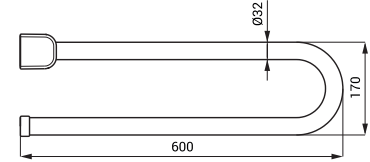
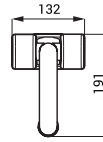

SLZM 17



SLZM 17 **49170** Stainless steel corner grab bar, fixed

SLZM 17X **49171** Stainless steel corner grab bar, fixed

- for disabled and persons with limited mobility
- mounting set
- dimensions 760 x 760 mm, Ø 32 mm
- polished finish (SLZM 17)
- brushed finish (SLZM 17X)

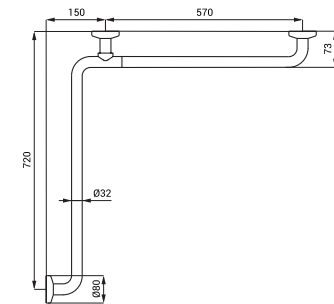

SLZM 17W



SLZM 17W **49172** Steel corner grab bar, fixed

- for disabled and persons with limited mobility
- mounting set
- dimensions 760 x 760 mm, Ø 32 mm
- white colour - Komaxit

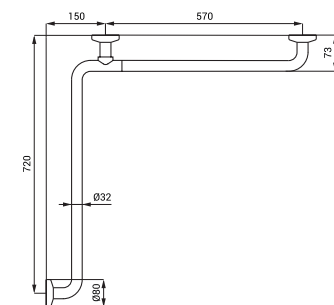

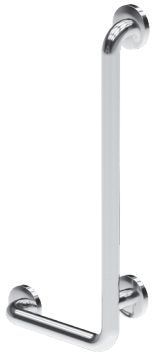

SLZM 18



SLZM 18 **49180** Stainless steel bath grab bar fixed, right

SLZM 18X **49181** Stainless steel bath grab bar fixed, right

- for disabled and persons with limited mobility

- mounting set
- dimensions 350 x 660 mm, Ø 32 mm
- polished finish (SLZM 18)
- brushed finish (SLZM 18X)

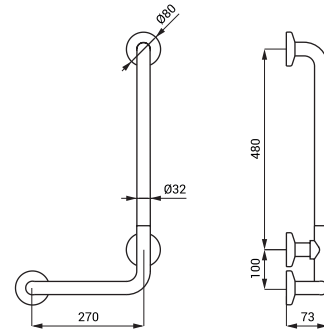

SLZM 18W



SLZM 18W **49182** Steel bath grab bar fixed, right

- for disabled and persons with limited mobility

- mounting set
- dimensions 350 x 660 mm, Ø 32 mm
- white colour - Komaxit

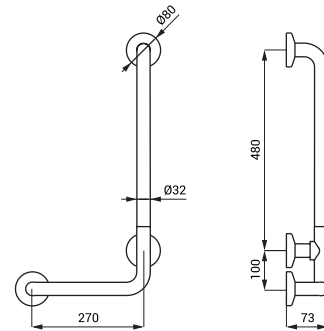

SLZM 19



SLZM 19 **49190** Stainless steel bath grab bar fixed, left

SLZM 19X **49191** Stainless steel bath grab bar fixed, left

- for disabled and persons with limited mobility

- mounting set
- dimensions 350 x 660 mm, Ø 32 mm
- polished finish (SLZM 19)
- brushed finish (SLZM 19X)

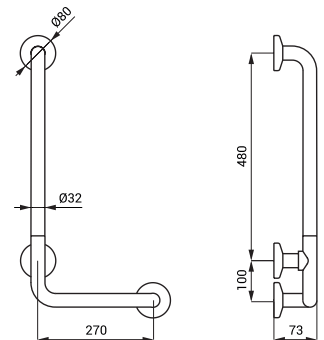

SLZM 19W



SLZM 19W **49192** Steel bath grab bar fixed, left

- for disabled and persons with limited mobility

- mounting set
- dimensions 350 x 660 mm, Ø 32 mm
- white colour - Komaxit

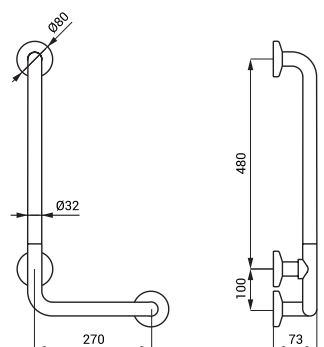



SLZM 21



SLZM 21 **49210** Stainless steel bath grab bar fixed

SLZM 21X **49211** Stainless steel bath grab bar fixed

- for disabled and persons with limited mobility
- mounting set
- dimensions 470 x 190 x 73 mm, Ø 32 mm
- polished finish (SLZM 21)
- brushed finish (SLZM 21X)

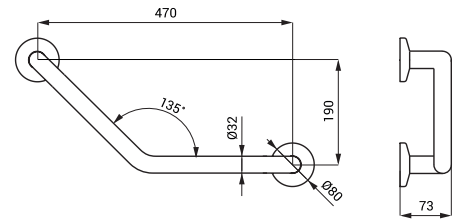

SLZM 21W



SLZM 21W **49212** Steel bath grab bar fixed

- for disabled and persons with limited mobility
- mounting set
- dimensions 470 x 190 x 73 mm, Ø 32 mm
- white colour - Komaxit

